

YAMAHA AX-550 RS /450

85W + 85W (8Ω) RMS Output Power, 0.015% THD, 20-20,000 Hz (AX-550)

65W + 65W (8Ω) RMS Output Power, 0.015% THD, 20-20,000 Hz (AX-450)

Pure Direct for High Quality Sound

Increased Low Impedance Drive Ability

High Quality Component Parts

Remote Control Capability (AX-550 Only)

Thank you for selecting the YAMAHA Stereo Amplifier.

CENTER



OWNER'S MANUAL

CONTENTS

Safety Instructions	2
Caution	2
Warning	3
Supplied Accessories (AX-550 Only)	3
Connections	4
Operations	6
Remote-Control Transmitter (AX-550 Only)	9
Notes about the Remote Control Transmitter (AX-550 Only)	10
Troubleshooting	10
Specifications	11

IMPORTANT!

Please make a note of the serial number of this unit in the space indicated below.

Model:
Serial No.:

The serial number is inscribed on the rear of the unit.
Keep this Owner's Manual in a safe place for future reference.

WARNING

To reduce the risk of fire or electric shock, do not expose this appliance to rain or moisture.



• Explanation of Graphical Symbols



The lightning flash with arrowhead symbol, within an equilateral triangle, is intended to alert you to the presence of uninsulated "dangerous voltage" within the product's enclosure that may be of sufficient magnitude to constitute a risk of electric shock to persons.



The exclamation point within an equilateral triangle is intended to alert you to the presence of important operating and maintenance (servicing) instructions in the literature accompanying the appliance.

SAFETY INSTRUCTIONS

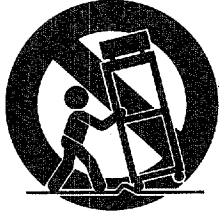
- 1 Read Instructions – All the safety and operating instructions should be read before the appliance is operated.
- 2 Retain Instructions – The safety and operating instructions should be retained for future reference.
- 3 Heed Warnings – All warnings on the appliance and in the operating instructions should be adhered to.
- 4 Follow Instructions – All operating and other instructions should be followed.
- 5 Water and Moisture – The appliance should not be used near water – for example, near a bathtub, washbowl, kitchen sink, laundry tub, in a wet basement, or near a swimming pool, etc.
- 6 Carts and Stands – The appliance should be used only with a cart or stand that is recommended by the manufacturer.
- 6A An appliance and cart combination should be moved with care. Quick stops, excessive force, and uneven surfaces may cause the appliance and cart combination to overturn. 
- 7 Wall or Ceiling Mounting – The appliance should be mounted to a wall or ceiling only as recommended by the manufacturer.
- 8 Ventilation – The appliance should be situated so that its location or position does not interfere with its proper ventilation. For example, the appliance should not be situated on a bed, sofa, rug, or similar surface, that may block the ventilation openings; or placed in a built-in installation, such as a bookcase or cabinet that may impede the flow of air through the ventilation openings.
- 9 Heat – The appliance should be situated away from heat sources such as radiators, stoves, or other appliances that produce heat.
- 10 Power Sources – The appliance should be connected to a power supply only of the type described in the operating instructions or as marked on the appliance.
- 11 Power-Cord Protection – Power-supply cords should be routed so that they are not likely to be walked on or pinched by items placed upon or against them, paying particular attention to cords at plugs, convenience receptacles, and the point where they exit from the appliance.
- 12 Cleaning – The appliance should be cleaned only as recommended by the manufacturer.
- 13 Nonuse Periods – The power cord of the appliance should be unplugged from the outlet when left unused for a long period of time.
- 14 Object and Liquid Entry – Care should be taken so that objects do not fall into and liquids are not spilled into the inside of the appliance.
- 15 Damage Requiring Service – The appliance should be serviced by qualified service personnel when:
 - A. The power-supply cord or the plug has been damaged; or
 - B. Objects have fallen, or liquid has been spilled into the appliance; or
 - C. The appliance has been exposed to rain; or
 - D. The appliance does not appear to operate normally or exhibits a marked change in performance; or
 - E. The appliance has been dropped, or the cabinet damaged.
- 16 Servicing – The user should not attempt to service the appliance beyond those means described in the operating instructions. All other servicing should be referred to qualified service personnel.
- 17 Power Lines – An outdoor antenna should be located away from power lines.
- 18 Grounding or Polarization – The precautions that should be taken so that the grounding or polarization is not defeated.

CAUTION: READ THIS BEFORE OPERATING YOUR UNIT

- 1 To ensure the finest performance, please read this manual carefully. Keep it in a safe place for future reference.
- 2 Install your unit in a cool, dry, clean place – away from windows, heat sources, and too much vibration, dust, moisture or cold. Avoid sources of hum (transformers, motors). To prevent fire or electrical shock, do not expose to rain and water.
- 3 Do not operate the unit upside-down. It may overheat, possibly causing damage.
- 4 Never open the cabinet. If a foreign object drops into the set, contact your dealer.
- 5 Do not use force on switches, knobs or cords. When moving the set, first turn the unit off. Then gently disconnect the power plug and the cords connecting to other equipment. Never pull the cord itself.
- 6 Do not attempt to clean the unit with chemical solvents; this might damage the finish. Use a clean, dry cloth.
- 7 Always set the volume control to “-∞” before starting the audio source play; increase the volume gradually to an appropriate level after the play is started.
- 8 Be sure to read the “Troubleshooting” section on common operating errors before concluding that your unit is faulty.
- 9 Do not connect audio equipment to the AC outlets on the rear panel if that equipment requires more power than the outlets are rated to provide.

WARNING: CHEMICAL CONTENT NOTICE!

The solder used in the manufacture of this product contains LEAD. In addition, the electrical/electronic and/or plastic (where applicable) components may also contain traces of chemicals found by the California Health and Welfare Agency (and possibly other entities) to cause cancer and/or birth defects or other reproductive harm.

DO NOT REMOVE ANY ENCLOSURE COMPONENTS! There are no user serviceable parts inside. All service should be performed by a service representative authorized by Yamaha to perform such service.

IMPORTANT MESSAGE: Yamaha strives to produce products that are both user safe and environmentally "friendly". We sincerely believe that our products meet these goals. However, in keeping with both the spirit and the letter of various statutes we have included the preceding messages and others in various locations in this manual.

FCC INFORMATION (U.S.A.)

1. IMPORTANT NOTICE : DO NOT MODIFY THIS UNIT!

This product, when installed as indicated in the instructions contained in this manual, meets FCC requirements. Modifications not expressly approved by Yamaha may void your authority, granted by the FCC, to use the product.

2. IMPORTANT : When connecting this product to accessories and/or another product use only high quality shielded cables. Cable/s supplied with this product **MUST** be used. Follow all installation instructions. Failure to follow instructions could void your FCC authorization to use this product in the USA.

3. NOTE : This product has been tested and found to comply with the requirements listed in FCC Regulations, Part 15 for Class "B" digital devices. Compliance with these requirements provides a reasonable level of assurance that your use of this product in a residential environment will not result in harmful interference with other electronic devices. This equipment generates/uses radio frequencies and, if not installed and used according to the instructions found in the users manual, may cause interference harmful to the operation of other electronic devices.

Compliance with FCC regulations does not guarantee that interference will not occur in all installations. If this product is found to be the source of interference, which can be determined by turning the unit "OFF" and "ON", please try to eliminate the problem by using one of the following measures:

Relocate either this product or the device that is being affected by the interference.

Utilize power outlets that are on different branch (circuit breaker or fuse) circuits or install AC line filter/s.

In the case of radio or TV interference, relocate/reorient the antenna. If the antenna lead-in is 300 ohm ribbon lead, change the lead-in to coaxial type cable.

If these corrective measures do not produce satisfactory results, please contact the local retailer authorized to distribute this type of product. If you can not locate the appropriate retailer, please contact Yamaha Electronics Corp., U.S.A. 6722 Orangethorpe Ave, Buena Park, CA 90620.

The above statements apply **ONLY** to those products distributed by Yamaha Corporation of America or its subsidiaries.

SUPPLIED ACCESSORIES (AX-550 ONLY)

After unpacking, check that the following parts are contained.

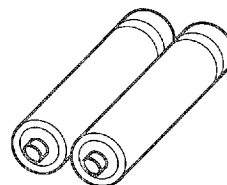
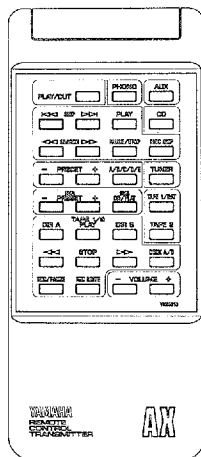

CONNECTIONS

Before attempting to make any connections to or from this unit, be sure to first switch OFF the power to this unit and to any other components to which connections are being made.

AUDIO CONNECTIONS

When making connections between this unit and other components, be sure all connections are made correctly, that is to say L (left) to L, R (right) to R, "+" to "+" and "-" to "-". Also, refer to the owner's manual for each component to be connected to this unit.

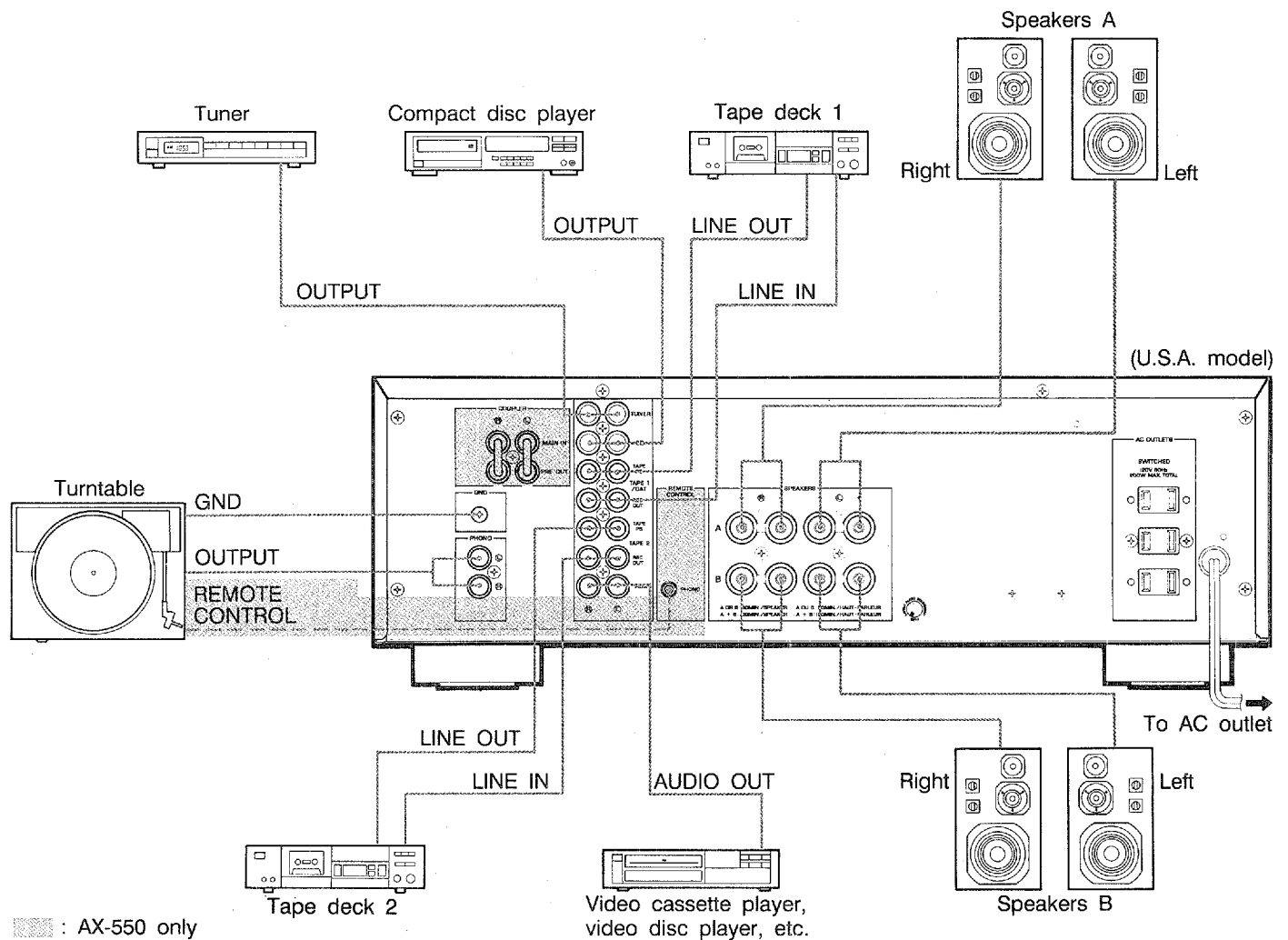

Connecting speaker systems

Connect the **SPEAKERS** terminals to your speakers with wire of the proper gauge, cut to be as short as possible. If the connections are faulty, no sound will be heard from the speakers. Make sure that the polarity of the speaker wires is correct, that is, + and - markings are observed. If these wires are reversed, the sound will be unnatural and will lack bass. **Do not let the bare speaker wires touch each other and do not let them touch the metal parts of this unit as this could damage this unit and/or speakers.**

- One or two speaker systems can be connected to this unit. If you connect only one speaker system, connect it to either **SPEAKERS A** or **B** terminals.

• How to Connect:

Red: positive (+)
Black: negative (-)

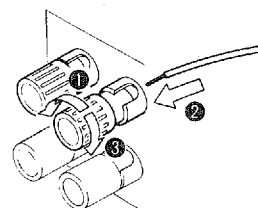

- 1 Unscrew the knob.
- 2 Insert the bare wire.
- 3 Tighten the knob and secure the wire.

About the accessory terminals

● AC OUTLETS (EXCEPT EUROPE MODEL)

Use these to connect the power cords from your components to this unit.

The power to the **SWITCHED** outlets is controlled by this unit's **POWER** switch. They will supply power to any component whenever this unit is turned on.

<AX-550>

U.S.A. and General Models

The maximum power (total power consumption of components) that can be connected to the **SWITCHED AC OUTLETS** is 200 watts.

Canada Model

The maximum power (total power consumption of components) that can be connected to the **SWITCHED AC OUTLETS** is 80 watts.

<AX-450>

U.S.A. and General Models

The maximum power (total power consumption of components) that can be connected to the **SWITCHED AC OUTLETS** is 200 watts.

Canada Model

The maximum power (total power consumption of components) that can be connected to the **SWITCHED AC OUTLETS** is 100 watts.

● GND terminal (For turntable use)

Connecting the ground wire of the turntable to this terminal will minimize hum, but in some cases better results may be obtained with the ground wire disconnected.

● PRE OUT/MAIN IN terminals <AX-550 Only>

Removing the jumper pins enables this unit to independently perform the functions of a control amplifier and a power amplifier. These terminals are for connection of a signal-processing system such as a graphic equalizer or sound processor.

If a sound processor or other component is connected, the **VOLUME** control of this unit can be used for overall adjustment of the level of sound. To connect such a unit, remove the jumper pins from the **PRE OUT/MAIN IN** terminals, connect the inputs of that unit to the **PRE OUT** terminals and its outputs to the **MAIN IN** terminals. For details, refer to the Owner's Manual included with the unit to be connected.

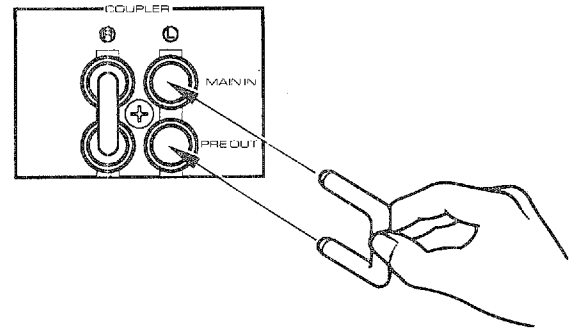

● REMOTE CONTROL (PHONO) connector <AX-550 Only>

If you have a YAMAHA turntable with the **ERS** mark, connect it to this connector by using the cable provided with the turntable. This connection allows you to control the turntable from the provided remote control transmitter.

OPERATIONS

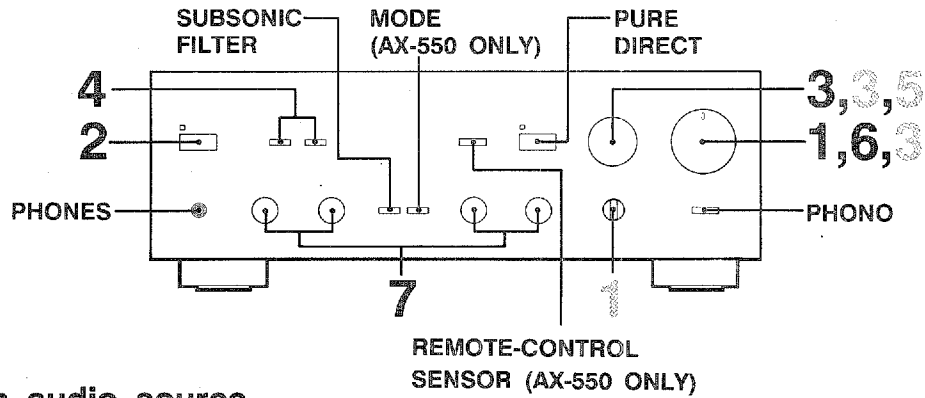

To listen to an audio source

- 1**

Set to the "∞" position.
- 2**
- 3** Select the source you want to listen to.
- 4** Select the speaker system to be used by pressing the **SPEAKERS** switches. (Refer to the next page for details.)
- 5** Play the source.
- 6**

Adjust to the desired output level.

7 If desired, adjust the **BASS, TREBLE, BALANCE** and **LOUDNESS** controls, etc.. (Refer to the next page for details.)

To record a source to audio tape (or dub from a tape to another)

- 1** Select the source to be recorded.
- 2** Play the source.
- 3** Confirm the source by selecting it with the **INPUT** selector and turning up the **VOLUME** control.
- 4** Set the tape deck in the recording mode.
- 5** If your tape deck has three head monitoring capability you can monitor the signal just recorded by selecting the corresponding tape source.

* Also, refer to the manual of the tape deck being used.

Notes

- If you want to enjoy another source while recording, select it with the **INPUT** selector.
- Adjusting the **VOLUME, LOUDNESS, BASS, TREBLE** and **BALANCE** controls during recording has no effect on the material being recorded.

Adjusting the BALANCE control

Adjust the balance of the output volume to the left and right speakers to compensate for sound imbalance caused from the speaker settings or the listening room condition.

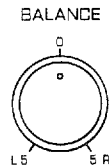

Selecting the SPEAKER system

Because one or two speaker systems can be connected to this unit, the **SPEAKERS** switches allow you to select speaker system A or B, or both at once.

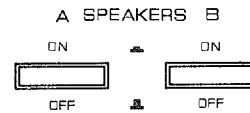

Adjusting the BASS and TREBLE controls

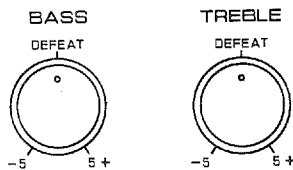

BASS : Turn this clockwise to increase (or counter-clockwise to decrease) the low frequency response.

TREBLE : Turn this clockwise to increase (or counter-clockwise to decrease) the high frequency response.

Adjusting the continuous variable LOUDNESS control

This control provides compensation for the human ears' loss of sensitivity to high and low-frequency ranges at low volume. This control is adjustable to retain full tonal range at any volume level.

1

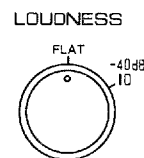

Set to the "FLAT" position.

2

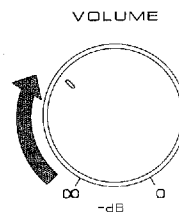

Set to the loudest listening level that you would listen to.

3

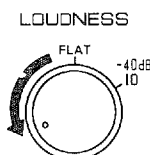

Turn so that the desired volume level can be achieved.

Setting the PHONO switch

Select either **MM** or **MC** position depending on your PHONO cartridge, Moving Magnet or Moving Coil type. However, if you use a high output MC cartridge, select the **MM** position.

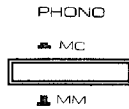

Setting the MODE switch (AX-550 only)

This switch can be used for switching between stereo and monaural operation. Normally this switch should be set to the **STEREO** position.

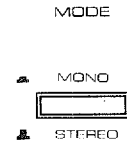

Using the PURE DIRECT switch

You can enjoy purer source sound by setting this switch so that the indicator illuminates. Because, by doing so, the input signal is output directly, bypassing the **MODE** switch (AX-550 only), **BASS**, **TREBLE**, **BALANCE**, **LOUDNESS** controls and **SUBSONIC FILTER** switch, therefore avoiding any "muddying" caused by circuit routing.

Concerning AX-550 only, the **PRE OUT/MAIN IN** terminals are also bypassed.

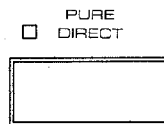

When you listen with headphones

Connect the headphones to the **PHONES** jack. When listening with headphones privately, set both the **SPEAKERS A** and **B** switches to the **OFF** position.

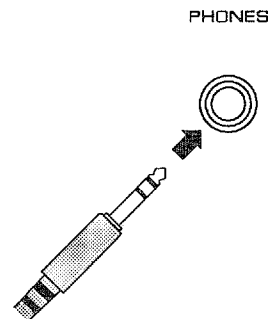

Setting the SUBSONIC FILTER

If you set the switch to the **ON** position, ultra-low-frequency signals caused by turntable rumble or warped records can be cut out without losing sound quality.



REMOTE-CONTROL TRANSMITTER (AX-550 ONLY)

The remote-control transmitter provided with this unit is designed to control all the most commonly used functions of the unit. If the CD player, turntable, equalizer, tuner, and tape deck connected to this unit are YAMAHA components designed for remote control compatibility (components with an **ERS** mark), then this remote-control transmitter will also control various functions of each component. Please consult YAMAHA dealer for information on which components are compatible with the remote-control transmitter.

Key Functions

For Amplifier Control

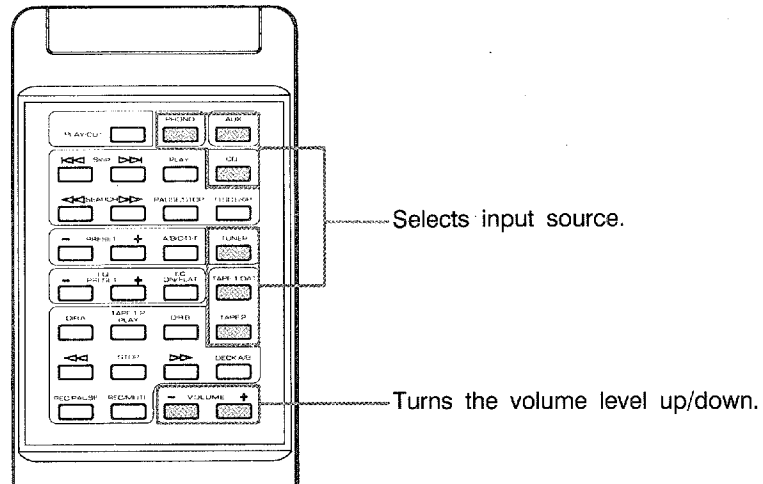

For Other Component Control

Identify the remote-control transmitter keys with your component's keys. If these keys are identical, their function will be the same. On each key function, refer to the corresponding instruction on your component's manual.

Controls compact disc player.
* **DISC SKIP** is applicable only to compact disc auto changer.

Selects preset station number.
* +: Selects higher preset station number.
* -: Selects lower preset station number.

Controls equalizer.
* + and - keys select any preset equalizer curve whenever they are pressed.

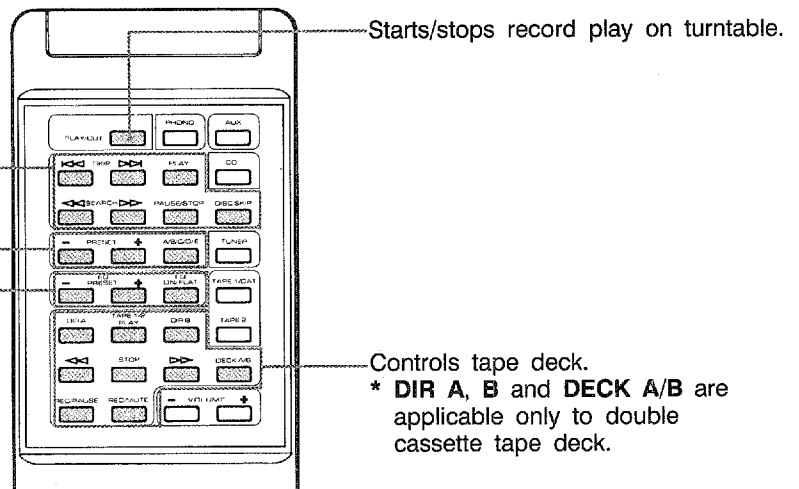

Starts/stops record play on turntable.

Controls tape deck.
* **DIR A, B** and **DECK A/B** are applicable only to double cassette tape deck.

NOTES ABOUT THE REMOTE CONTROL TRANSMITTER (AX-550 ONLY)

Battery installation

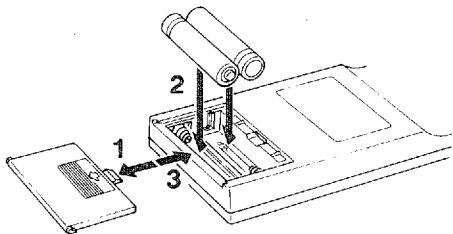

Battery replacement

If the remote-control transmitter must be used closer to the main unit, the batteries are weak. Replace both batteries with new ones.

Notes

- Use only "AAA" (R03) batteries for replacement.
- Be sure the polarities are correct. (See the illustration inside the battery compartment.)
- Remove the batteries if the remote-control transmitter will not be used for an extended period of time.
- If batteries leak, immediately dispose of them. Avoid touching the leaked material or letting it come in contact with clothing, etc. Clean the battery compartment thoroughly before installing new batteries.

Remote-control transmitter operation range

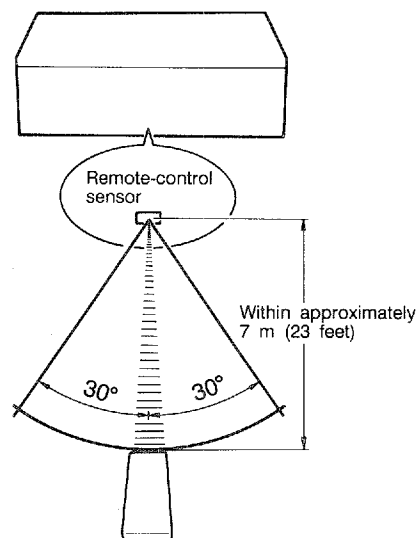

There should be no large obstacles between the remote-control transmitter and the main unit.

TROUBLESHOOTING

Before assuming that your unit is faulty, please check the following troubleshooting list, which details corrective actions you can take yourself without calling a service engineer. If you have any questions, contact your nearest Yamaha dealer.

PROBLEM	POSSIBLE CAUSES	REMEDY
Power is not supplied even though the POWER switch is ON.	The power plug is not securely connected.	Connect it securely.
There is no sound when any input selector is pressed.	The correct SPEAKERS switch is not set.	Use the correct SPEAKERS switch.
	The input wires are not connected securely.	Connect them securely.
	The speaker systems are not connected correctly.	Check and secure the connections.
There is no sound from one speaker.	The speaker connections are not secure.	Secure the connections.
	The BALANCE control is set all the way to the left or right.	Adjust the BALANCE control correctly.
There is a lack of bass, and no ambience.	The + and - wires are connected in reversed at the amplifier or speakers.	Connect the speaker wires in the correct phase (+ and -).
There is a humming sound when playing records.	The input wires are not connected securely.	Connect the input wires securely.
	The turntable's ground wire is not connected.	Connect the ground wire.
There is a howling sound when playing records at high volume.	The turntable and the speakers are too close together, or the turntable is not located on a firm surface.	Change the location of the turntable or the speakers.
Using the MODE switch (AX-550 only), BASS, TREBLE, BALANCE, LOUDNESS controls and SUBSONIC FILTER switch does not affect the tone.	The PURE DIRECT switch is ON.	The PURE DIRECT switch must be switched OFF to use the controls.
The sound suddenly stops.	Using outside the rated impedance range at high power for an extended period has activated the speaker protection circuit.	Switching this unit OFF and then ON will reset the speaker protection circuit. Use speakers within the rated impedance range.
	There is a malfunction in the amplifier.	Consult your Yamaha dealer.

SPECIFICATIONS

Minimum RMS Output Power Per Channel

AX-550
 20 Hz - 20 kHz 0.015% THD 8Ω 85W
 20 Hz - 20 kHz 0.03% THD 6Ω
 U.S.A. model 95W
 Except U.S.A. model 100W

AX-450
 20 Hz - 20 kHz 0.015% THD 8Ω 65W
 20 Hz - 20 kHz 0.03% THD 6Ω
 U.S.A. model 75W
 Except U.S.A. model 80W

Dynamic Power Per Channel (by IHF Dynamic Headroom Measuring Method)

AX-550
 8Ω/6Ω/4Ω/2Ω 135W/160W/195W/230W
 AX-450
 8Ω/6Ω/4Ω/2Ω 110W/130W/160W/190W

DIN Standard Output Power Per Channel (European model)

AX-550
 1 kHz 0.7% THD 4Ω 140W
 AX-450
 1 kHz 0.7% THD 4Ω 100W

Dynamic Headroom (U.S.A., Canadian and General models)

AX-550
 8Ω 2.01 dB
 6Ω 2.26 dB
 AX-450
 8Ω 2.28 dB
 6Ω 2.39 dB

IEC Power (European model)

AX-550
 1 kHz 0.01% THD 8Ω 105W
 AX-450
 1 kHz 0.01% THD 8Ω 85W

Power Bandwidth

AX-550
 0.03% THD 42.5W 8Ω 10 Hz - 50 kHz
 AX-450
 0.03% THD 32.5W 8Ω 10 Hz - 50 kHz

Damping Factor

1 kHz 8Ω 250 or more

Input Sensitivity/Impedance

Phono MC 160 μV 220Ω
 MM 2.5 mV/47 kΩ
 CD/TUNER/AUX/TAPE/DAT
 150 mV/47 kΩ
 MAIN IN (AX-550 only) 1V/14 kΩ

Input Sensitivity (New IHF) (U.S.A., Canadian and General models)

Phono MC 19 μV
 MM 0.27 mV
 CD/AUX/TUNER/TAPE/DAT 15.5 mV

Maximum Input level (1 kHz 0.01% THD)

Phono MC 10 mV
 MM 150 mV

Output Level/Impedance

REC OUT 150 mV 220Ω
 PRE OUT (AX-550 only) 1V/470Ω
 Maximum Voltage Output (AX-550 only)
 20 Hz - 20 kHz 0.01% THD 6.0V

Headphone Jack Rated Output/Impedance

AX-550
 0.01% THD RL=8Ω 0.52V/390Ω
 AX-450
 0.015% THD RL=8Ω 0.54V/330Ω

Frequency Response

CD/TUNER/AUX/TAPE/DAT
 20 Hz - 20 kHz, 0±0.5 dB
 MAIN IN (AX-550 only)
 20 Hz - 20 kHz, 0±0.5 dB

RIAA Equalization Deviation

20 Hz - 20 kHz,
 Phono MC ±0.5 dB
 MM ±0.3 dB

Total Harmonic Distortion 20 Hz - 20 kHz

Phono MC to REC OUT, 3V 0.007%
 MM to REC OUT, 3V 0.003%

AX-550

CD/TUNER/AUX/TAPE/DAT to
 Pre Out, 3V 0.005%
 CD/TUNER/AUX/TAPE/DAT to
 Sp Out, 42.5W/8Ω 0.008%
 MAIN IN to Sp Out, 42.5W/8Ω 0.006%

AX-450

CD/TUNER/AUX/TAPE/DAT to
 Sp Out, 32.5W/8Ω 0.01%

Intermodulation Distortion

CD/TUNER/AUX/TAPE/DAT
 Rated Output/8Ω 0.01%

Signal-to-Noise Ratio (IHF-A Network)

(Pure Direct Switch: ON)
 AX-550
 Phono MC (500 μV Input Shorted) 76 dB
 MM (5 mV Input Shorted) 92 dB
 CD/TUNER/AUX/TAPE/DAT (Shorted)
 110 dB

AX-450

Phono MC (500 μV Input Shorted) 75 dB
 MM (5 mV Input Shorted) 90 dB
 CD/TUNER/AUX/TAPE/DAT (Shorted)
 110 dB

Signal-to-Noise Ratio (New IHF)

(Pure Direct Switch: ON)
 AX-550
 Phono MC 75 dB
 MM 77 dB
 CD/AUX/TUNER/TAPE/DAT 87 dB

AX-450

Phono MC 75 dB
 MM 76 dB
 CD/AUX/TUNER/TAPE/DAT 87 dB

Residual Noise (IHF-A Network)

(Pure Direct Switch: ON) 70 μV
 Channel Separation Vol -30 dB
 Phono MC, MM Input shorted
 1 kHz/10 kHz 75 dB/60 dB
 CD/TUNER/AUX/TAPE/DAT
 Input 5.1 kΩ
 Terminated 1 kHz/10 kHz 65 dB/50 dB

Tone Control Characteristics

Bass

Boost / Cut ±10 dB (20 Hz)
 Turnover frequency 350 Hz

Treble

Boost / Cut ±10 dB (20 kHz)
 Turnover frequency 3.5 kHz

Filter Characteristics (Subsonic)

AX-550 15 Hz, 18 dB/oct
 AX-450 15 Hz, 12 dB/oct

Continuous Loudness Control (Level Related Equalization)

Attenuation -40dB (1 kHz)

Gain Tracking Error (0 - -60 dB)

AX-550 2 dB
 AX-450 3 dB

Power Supply

U.S.A. and Canadian model ... AC 120V/60 Hz
 British and Australian models
 AC 240V/50 Hz
 European model AC 230V/50 Hz
 General model
 AC 110/120/220/240V 60/50 Hz

Power Consumption

U.S.A. model 200W
 Canadian model 430W
 British, Australian, Europe (except Scandinavia)
 and General models 230W
 Scandinavian model 170W

AC Outlets Switched (3) (U.S.A., Canadian and General Models)

U.S.A. and General models 200W max.
 Canadian model
 AX-550 80W max.
 AX-450 100W max.

Dimensions (W x H x D)

..... 435 x 150 x 388.5 mm
 (17-1/8" x 5-7/8" x 15-5/16")

Weight

AX-550 11 kg
 (24 lbs. 3 oz.)
 AX-450 9.5 kg
 (20 lbs. 14 oz.)

Accessories Remote control transmitter Batteries

Specifications subject to change without notice.

YAMAHA

YAMAHA ELECTRONICS CORPORATION, USA 6722 ORANGETHORPE AVE., BUENA PARK, CALIF. 90620, U.S.A.
YAMAHA CANADA MUSIC LTD. 135 MILNER AVE., SCARBOROUGH, ONTARIO M1S 3R1, CANADA
YAMAHA ELECTRONIK EUROPA G.m.b.H. SIEMENSSTR. 22-34, D-2084 RELLINGEN BEI HAMBURG, F.R. OF GERMANY
YAMAHA ELECTRONIQUE FRANCE S.A. 17 RUE DES CAMPANULES, LOGNES 77321 MARNE LA VALLEE CEDEX 2, FRANCE
YAMAHA ELECTRONICS (UK) LTD. YAMAHA HOUSE, 200 RICKMANSWORTH ROAD WATFORD, HERTS WD1 7JS, ENGLAND

YAMAHA CORPORATION